

RoHS Compliant Small Form Factor Pluggable Transceiver for Fast Ethernet and SONET OC-3



FEATURES

- Compliant with SFP Transceiver MSA specification
- Compliant with Specifications for IEEE 802.3 100Gase Fast Ethernet
- Compliant with Industry Standard RFT Electrical Connector and Cage
- Single + 3.3V Power Supply and TTL Logic Interface
- EEPROM with Serial ID Functionality
- Laser Class 1 Product which comply with the requirements of IEC 60825-1 and IEC 60825-2
- Duplex LC Connector interface

Description

The LCP-155A4HSRBx series are hot pluggable 3.3V Small-Form-Factor transceiver module designed for high-speed communication applications that require rates of up to 155Mbit/sec. It is compliant with the Fast Ethernet standards, as well as the SFP Multisource Agreement (MSA).

The LCP-155A4HSRBx transceivers provide with the LC receptacle that is compatible with the industry standard LC connector. The transceiver is also compatible with industry standard RFT connector and cage.

The post-amplifier of the LCP-155A4HSRBx also includes a LOS (Loss Of Signal) circuit that provides a TTL logic-high output when an unusable optical signal level is detected.

The LCP-155A4HSRBx transceiver is a Class 1 eye safety product. The optical power levels, under normal operation, are at eye safe level.

Applications

- 100Base Fast Ethernet
- Switch to Switch interface
- Switched backplane applications
- File server interface

Performance

- LCP-155A4HSRBx

Data Link up to 2km in 50/125 μ m Multi Mode Fiber

Data Link up to 1km in 62.5/125 μ m Multi Mode Fiber

Absolute Maximum Ratings

Parameter	Symbol	Min.	Typ.	Max.	Unit	Note
Storage Temperature	Ts	-40		85	°C	
Supply Voltage	VCC	0		5	V	

Recommended Operating Conditions

Parameter	Symbol	Min.	Typ.	Max.	Unit	Note
Case Operating Temperature Commercial	Tc	-5		70	°C	1
Extended		-10		85		
Industrial		-40		85		
Supply Voltage	VCC	3.135		3.465	V	

Note 1: See order information

Electrical Characteristics

(V_{CC}=3.135V to 3.465V)

Parameter	Symbol	Min.	Typ.	Max.	Unit	Note
Total Supply Current	ICCT			300	mA	
Transmitter						
Transmitter Differential Input Voltage	VDT	0.5		2.4	V	2
Transmitter Disable Input-High	V _{DISH}	2		V _{CC} +0.3	V	
Transmitter Disable Input-Low	V _{DISL}	0		0.8	V	
Transmitter Fault Output-High	V _{TXFH}	2		V _{CC} +0.3	V	3
Transmitter Fault Output-Low	V _{TXFL}	0		0.8	V	3
Receiver						
Receiver Differential Output Voltage	VDR	0.35	0.7	2	V	4
LOS Output Voltage-High	V _{LOSH}	2		V _{CC} +0.3	V	3
LOS Output Voltage-Low	V _{LOSL}	0		0.8	V	3
Output Data Rise/Fall Time	t _r / t _f			2.2	nsec	5

Notes:

- Internally AC coupled and terminated to 100Ohm differential load.
- Pull up to V_{CC} with a 4.7K – 10K Ohm resistor on host Board
- Internally AC coupled, but requires a 100 Ohm differential termination at or internal to Serializer/ Deserializer.
- These are 20%~80% values

Optical Characteristics (LCP-155A4HSRBx)

($V_{CC}=3.135V$ to $3.465V$, Data Rate= $125Mbps$, PRBS= 2^7-1 NRZ, $50/125\mu m$ or $62.5/125\mu m$ MMF)

Parameter	Symbol	Min.	Typ.	Max.	Unit	Note
Transmitter						
Output Optical Power (Avg.)	P_O	-10		-4	dBm	
Optical Extinction Ratio	ER	9			dB	
Center Wavelength	c	830	850	860	nm	
Spectral Width (RMS)				0.85	nm	
Optical Rise/Fall Time	t_r / t_f			2.5	nsec	1
Total Jitter(pk-pk)	TJ			2.5	ns	
Transmitter eye mask definition {X1, X2, X3, Y1, Y2, Y3, Y4}		{0.18, 0.29, 0.35, 0.35, 0.38, 0.4, 0.55}				UI
Receiver						
Sensitivity (Avg.)	PIN			-25	dBm	2
Input Optical Wavelength			850		nm	
LOS- De-Asserted (Avg.)	P_D			-26	dBm	
LOS- asserted (Avg.)	P_A	-38			dBm	
LOS-Hysteresis	P_D-P_A	0.5			dB	
Overload	P_O	-3			dBm	

Notes:

1. These are 20%~80% values
2. The sensitivity is provided at a BER of 1×10^{-12} or better with an input signal consisting of 125Mbps, 2^7-1 PRBS.

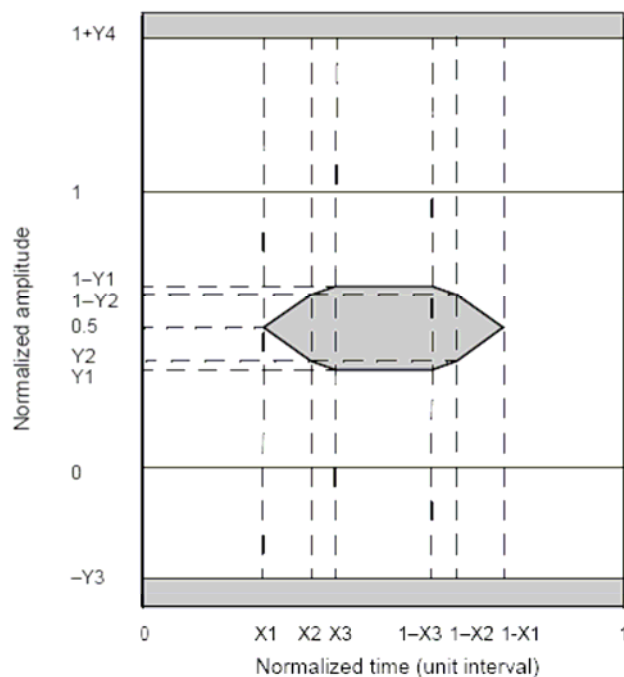
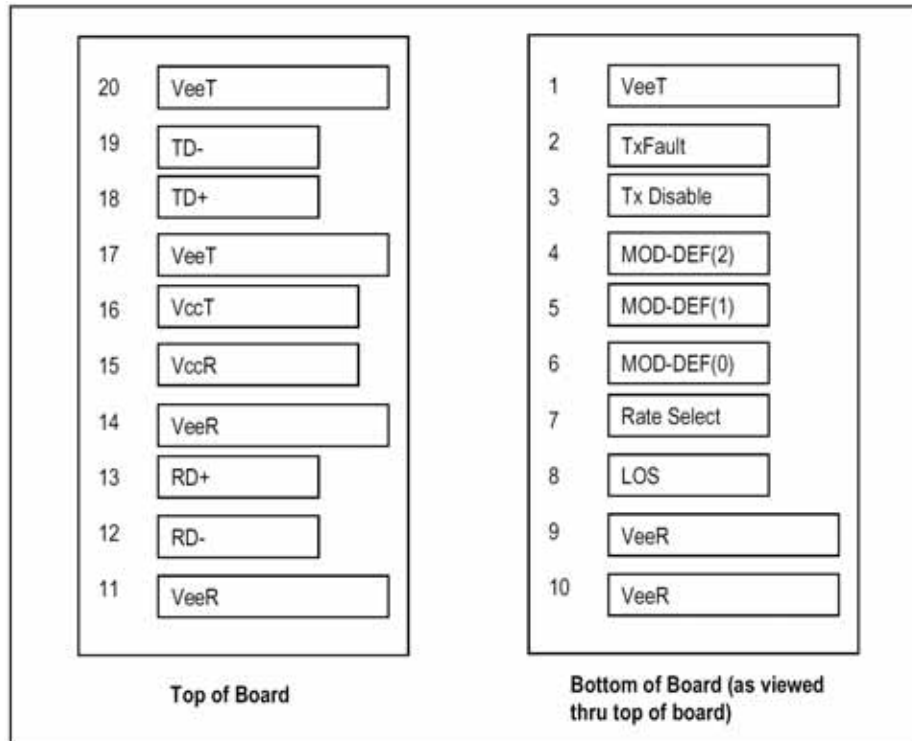

Figure 1 Tx output Eye Mask

SFP Transceiver Electrical Pad Layout



Pin Function Definitions

Pin Num.	Name	Function	Plug Seq.	Notes
1	VeeT	Transmitter Ground	1	
2	TX Fault	Transmitter Fault Indication	3	Note 1
3	TX Disable	Transmitter Disable	3	Note 2 Module disables on high or open
4	MOD-DEF2	Module Definition 2	3	Note 3, 2 wire serial ID interface
5	MOD-DEF1	Module Definition 1	3	Note 3, 2 wire serial ID interface
6	MOD-DEF0	Module Definition 0	3	Note 3, Grounded in Module
7	Rate Select	Not Connect	3	Function not available
8	LOS	Loss of Signal	3	Note 4
9	VeeR	Receiver Ground	1	Note 5
10	VeeR	Receiver Ground	1	Note 5
11	VeeR	Receiver Ground	1	Note 5
12	RD-	Inv. Received Data Out	3	Note 6
13	RD+	Received Data Out	3	Note 7
14	VeeR	Receiver Ground	1	Note 5
15	VccR	Receiver Power	2	3.3 ± 5%, Note 7
16	VccT	Transmitter Power	2	3.3 ± 5%, Note 7
17	VeeT	Transmitter Ground	1	Note 5
18	TD+	Transmit Data In	3	Note 8
19	TD-	Inv. Transmit Data In	3	Note 8
20	VeeT	Transmitter Ground	1	Note 5

Plug Seq.: Pin engagement sequence during hot plugging.

Notes:

- 1) TX Fault is an open collector/drain output, which should be pulled up with a 4.7K – 10K Ω resistor on the host board. Pull up voltage between 2.0V and VccT, R+0.3V. When high, output indicates a laser fault of some kind. Low indicates normal operation. In the low state, the output will be pulled to < 0.8V.
- 2) TX disable is an input that is used to shut down the transmitter optical output. It is pulled up within the module with a 4.7 – 10 K Ω resistor. Its states are:

Low (0 – 0.8V):	Transmitter on
(>0.8, < 2.0V):	Undefined
High (2.0 – 3.465V):	Transmitter Disabled
Open:	Transmitter Disabled
- 3) Mod-Def 0,1,2. These are the module definition pins. They should be pulled up with a 4.7K – 10K Ω resistor on the host board. The pull-up voltage shall be VccT or VccR (see Section IV for further details). Mod-Def 0 is grounded by the module to indicate that the module is present Mod-Def 1 is the clock line of two wire serial interface for serial ID Mod-Def 2 is the data line of two wire serial interface for serial ID
- 4) LOS (Loss of Signal) is an open collector/drain output, which should be pulled up with a 4.7K – 10K Ω resistor. Pull up voltage between 2.0V and VccT, R+0.3V. When high, this output indicates the received optical power is below the worst-case receiver sensitivity (as defined by the standard in use). Low indicates normal operation. In the low state, the output will be pulled to < 0.8V.
- 5) VeeR and VeeT may be internally connected within the SFP module.
- 6) RD-/+ : These are the differential receiver outputs. They are AC coupled 100 Ω differential lines which should be terminated with 100 Ω (differential) at the user SERDES. The AC coupling is done inside the module and is thus not required on the host board. The voltage swing on these lines will be between 370 and 2000 mV differential (185 – 1000 mV single ended) when properly terminated.
- 7) VccR and VccT are the receiver and transmitter power supplies. They are defined as 3.3V \pm 5% at the SFP connector pin. Maximum supply current is 300mA. Recommended host board power supply filtering is shown below. Inductors with DC resistance of less than 1 ohm should be used in order to maintain the required voltage at the SFP input pin with 3.3V supply voltage. When the recommended supply-filtering network is used, hot plugging of the SFP transceiver module will result in an inrush current of no more than 30mA greater than the steady state value. VccR and VccT may be internally connected within the SFP transceiver module.
- 8) TD-/+ : These are the differential transmitter inputs. They are AC-coupled, differential lines with 100 Ω differential termination inside the module. The AC coupling is done inside the module and is thus not required on the host board. The inputs will accept differential swings of 500 – 2400 mV (250 – 1200 mV single-ended), though it is recommended that values between 500 and 1200 mV differential (250 – 600 mV single-ended) be used for best EMI performance.

Recommend Circuit Schematic

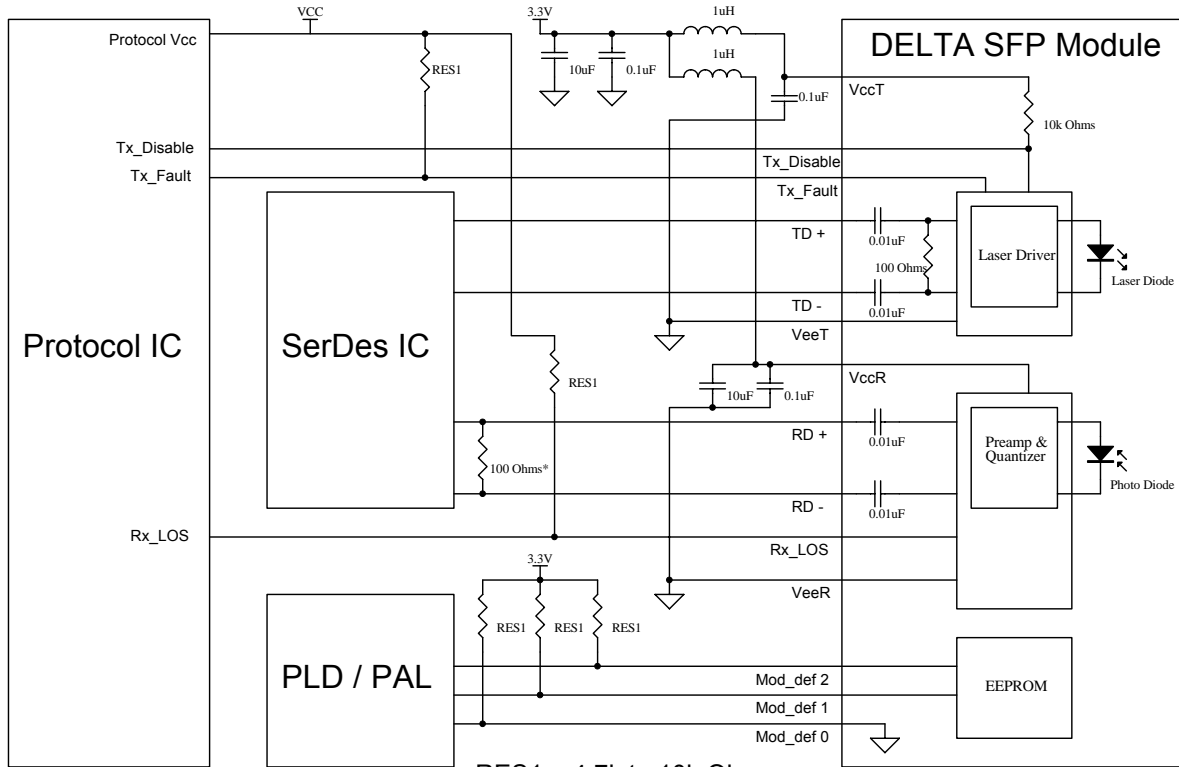

RES1 = 4.7k to 10k Ohms

* Depends on SerDes IC used

Package Outline Drawing for Metal Housing with Bail de-latch

Latch Color Identifier
Black

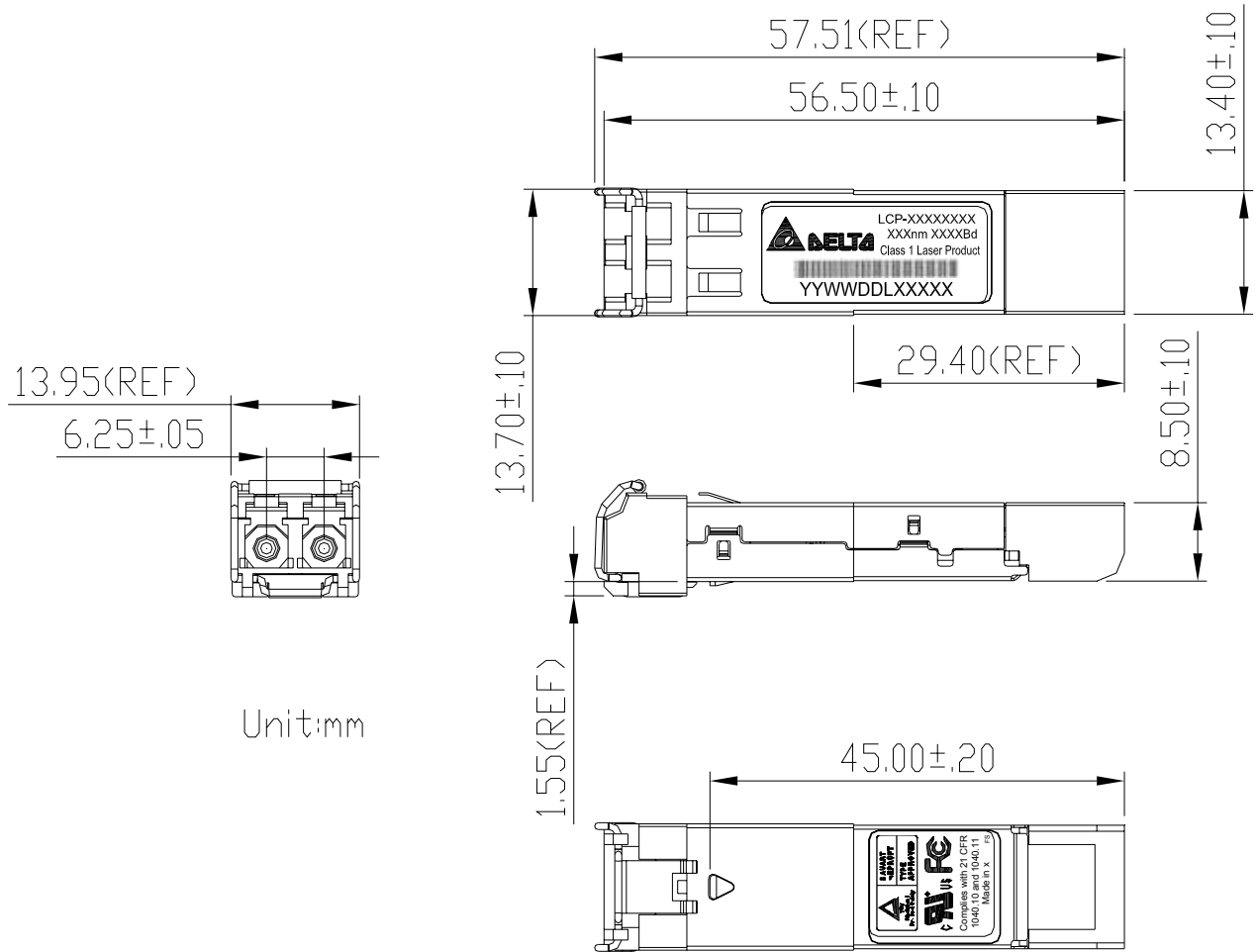

SFP timing parameters for SFP management

Parameter	Symbol	Min.	Max.	Unit	Unit Conditions
TX_DISABLE Assert time	t_off		10	μsec	Time from rising edge of TX_DISABLE to when the optical output falls below 10% of nominal
TX_DISABLE Negate time	t_on		1	msec	Time from falling edge of TX_DISABLE to when the modulated optical output rises above 90% of nominal
Time to initialize, including reset of TX_FAULT	t_init		300	msec	From power on or negation of TX_Fault using TX Disable.
TX Fault Assert Time	t_fault		100	μsec	Time from fault to TX fault on.
TX_DISABLE to reset	t_rest	10		μsec	Time TX Disable must be held high to reset TX_Fault
LOS Assert Time	t_loss_on		100	μsec	Time from LOS state to Rx LOS assert
LOS Deassert Time	t_loss_off		100	μsec	Time from non-LOS state to Rx LOS deassert
Serial ID Clock Rate	f_serial_clock		100	kHz	

SFP timing parameters

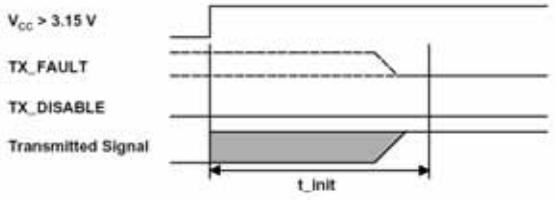
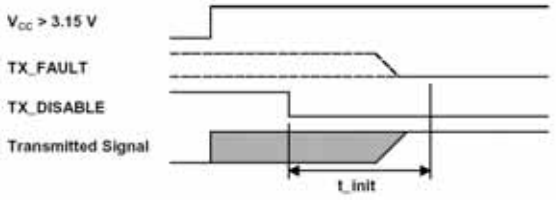
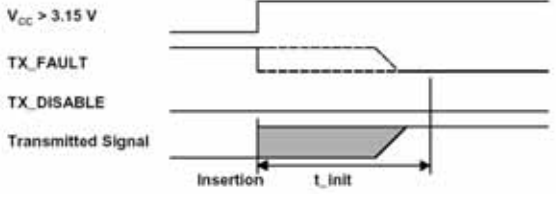
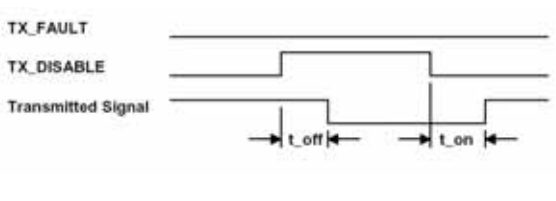
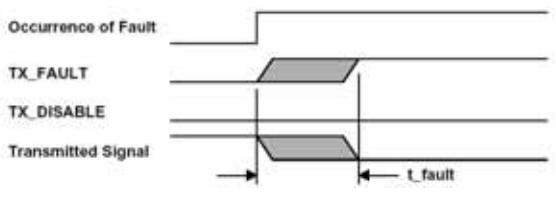
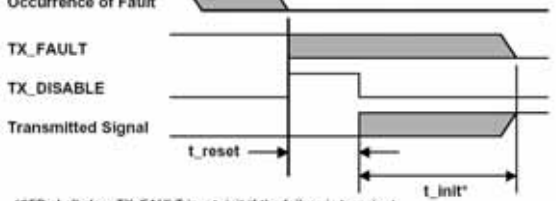
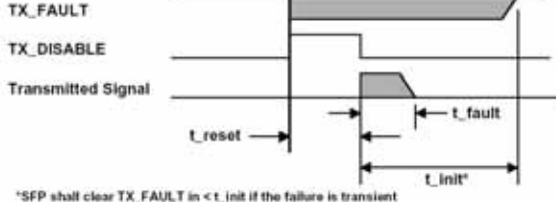
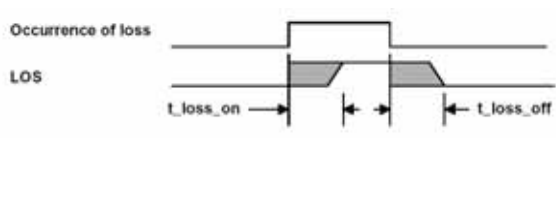
	
<p>Power on initialization of SFP transceiver, TX_DISABLE negated</p>	<p>Power on initialization of SFP, TX_DISABLE asserted</p>
	
<p>Example of initialization during hot plugging, TX_DISABLE negated.</p>	<p>SFP TX_DISABLE timing during normal operation.</p>
	 <p>*SFP shall clear TX_FAULT in <math>t_{init}^*</math> if the failure is transient</p>
<p>Detection of transmitter safety fault condition</p>	<p>Successful recovery from transient safety fault condition</p>
 <p>*SFP shall clear TX_FAULT in <math>t_{init}^*</math> if the failure is transient</p>	
<p>Unsuccessful recovery from safety fault condition</p>	<p>Timing of LOS detection</p>



LCP-155A4HSRB EEPROM Serial ID Memory Contents (2-Wire Address A0h)

Address	Hex	ASCII	Address	Hex	ASCII	Address	Hex	ASCII	Address	Hex	ASCII	Address	Hex	ASCII	Address	Hex	ASCII
00	03		25	20		50	53	S	75	SN		100	00		125	00	
01	04		26	20		51	52	R	76	SN		101	00		126	00	
02	07		27	20		52	42	B	77	SN		102	00		127	00	
03	00		28	20		53	20		78	SN		103	00				
04	00		29	20		54	20		79	SN		104	00				
05	01		30	20		55	20		80	SN		105	00				
06	00		31	20		56	41		81	SN		106	00				
07	00		32	20		57	20		82	SN		107	00				
08	00		33	20		58	20		83	SN		108	00				
09	00		34	20		59	20		84	DC	Note 3	109	00				
10	00		35	20		60	03		85	DC		110	00				
11	03		36	00		61	52		86	DC		111	00				
12	01		37	00		62	00		87	DC		112	00				
13	00		38	00		63	CS1	Note 1	88	DC		113	00				
14	00		39	00		64	00		89	DC		114	00				
15	00		40	4C	L	65	1A		90	DC		115	00				
16	C8		41	43	C	66	00		91	DC		116	00				
17	64		42	50	P	67	00		92	00		117	00				
18	00		43	2D	-	68	SN	Note 2	93	00		118	00				
19	00		44	31	1	69	SN		94	00		119	00				
20	44	D	45	35	5	70	SN		95	CS2	Note 4	120	00				
21	45	E	46	35	5	71	SN		96	00		121	00				
22	4C	L	47	41	A	72	SN		97	00		122	00				
23	54	T	48	34	4	73	SN		98	00		123	00				
24	41	A	49	48	H	74	SN		99	00		124	00				

Notes:

- 1) Byte 63: Check sum of bytes 0-62.
- 2) Byte 68-83 (SN): Serial number.
- 3) Byte 84-91 (DC): Date code.
- 4) Byte 95 (CS2): Check sum of bytes 64-94.
- 5) Byte 128-255 had been set hex. 00.



Regulatory Compliance

Feature	Reference	Performance
Electromagnetic Interference (EMI)	FCC CRF 47, Part15 Class B EN 55022 Class B (CISPR 22A)	(1) Satisfied with electrical characteristics of product spec. (2) No physical damage
Radio Frequency Electromagnetic Field	EN 61000-4-3 IEC 61000-4-3	
Electrostatic Discharge to the Duplex LC Receptacle	EN 61000-4-2 IEC 61000-4-2 IEC 801.2	
Electrostatic Discharge to the Electrical Pins	MIL-STD-883E Method 3015.7	
Eye Safety	US FDA CDRH AEL Class 1 EN 60950: 2000 EN 60825-1: 1994+A11+A2 EN 60825-2: 2000	CDRH File # 0321539-00 TUV Certificate No. R50032471
Component Recognition	Underwriters Laboratories and Canadian Standards Association Joint Component Recognition for Information Technology Equipment Including Electrical Business Equipment	UL File # E239394

Ordering information for SFP modules

LCP-155A4HSRBx

x: Temperature

Blank: -5 to +70 degree C

H: -10 to +85 degree C

T: -40 to +85 degree C

Revision History

Rev	Date	Contents
0A	Sep., 2007	Preliminary Datasheet
0B	Oct.16 2007	Modified the Byte6 of A0h from 00h to 20h Add the total jitter specification of TX
0C	Oct. 23 2007	Add latch color identifier Modify the Byte5,Byte6,Byte11 and Byte12 of A0h.
0D	Nov. 06, 2007	Modify the Byte 12 from 02h to 01h